

Bastelbogen Nr. 908o

Seite 1

kleiner 8-Spitz Stern, einseitig

Durchmesser : 12,4 cm

Höhe : 4,1 cm

Seiten : 2 + 1

Anzahl der Teile: 22

Schwierigkeit: S3 mittel



Copyright 2006-2012 Boris Voigt, Berlin-Hohenschönhausen
© bestimmte Rechte vorbehalten
Sie sind nicht berechtigt, Veränderungen
in diesem Bastelbogen vorzunehmen.
Ein Verkauf dieses Bastelbogens wird hiermit untersagt.
Die kostenlose Weitergabe dieses Bastelbogens ist erlaubt.



Projekt Bastelbogen

www.projekt-bastelbogen.de

Bastelbogen Nr. 908o

kleiner 8-Spitz Stern, einseitig

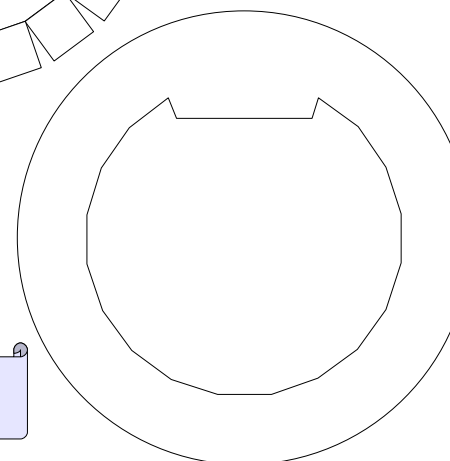
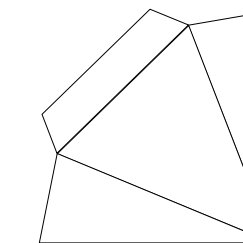
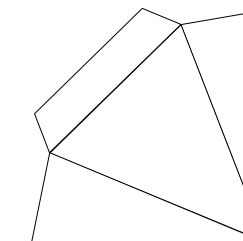
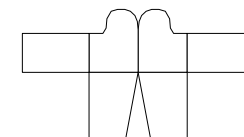
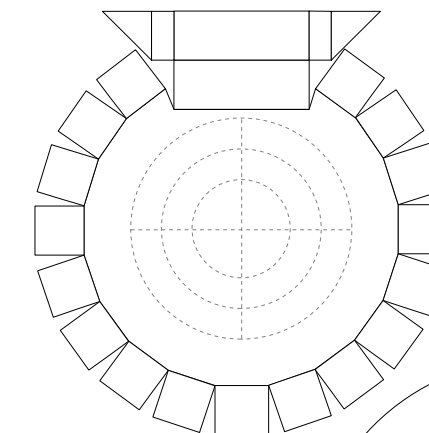
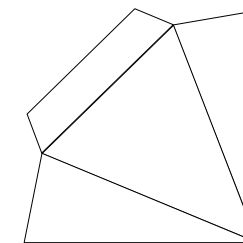
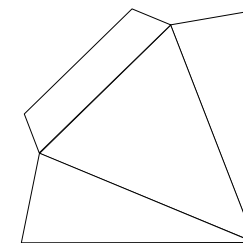
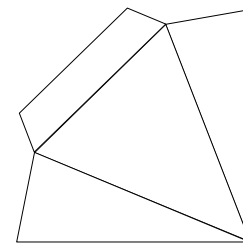
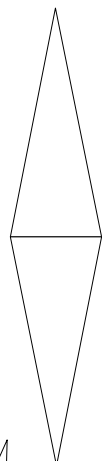
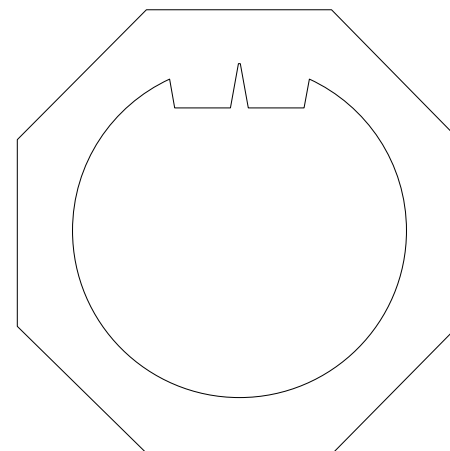
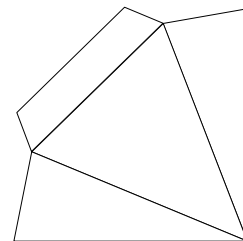
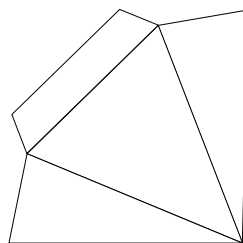
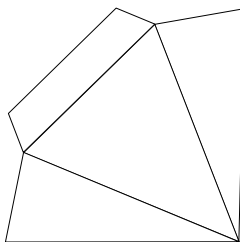
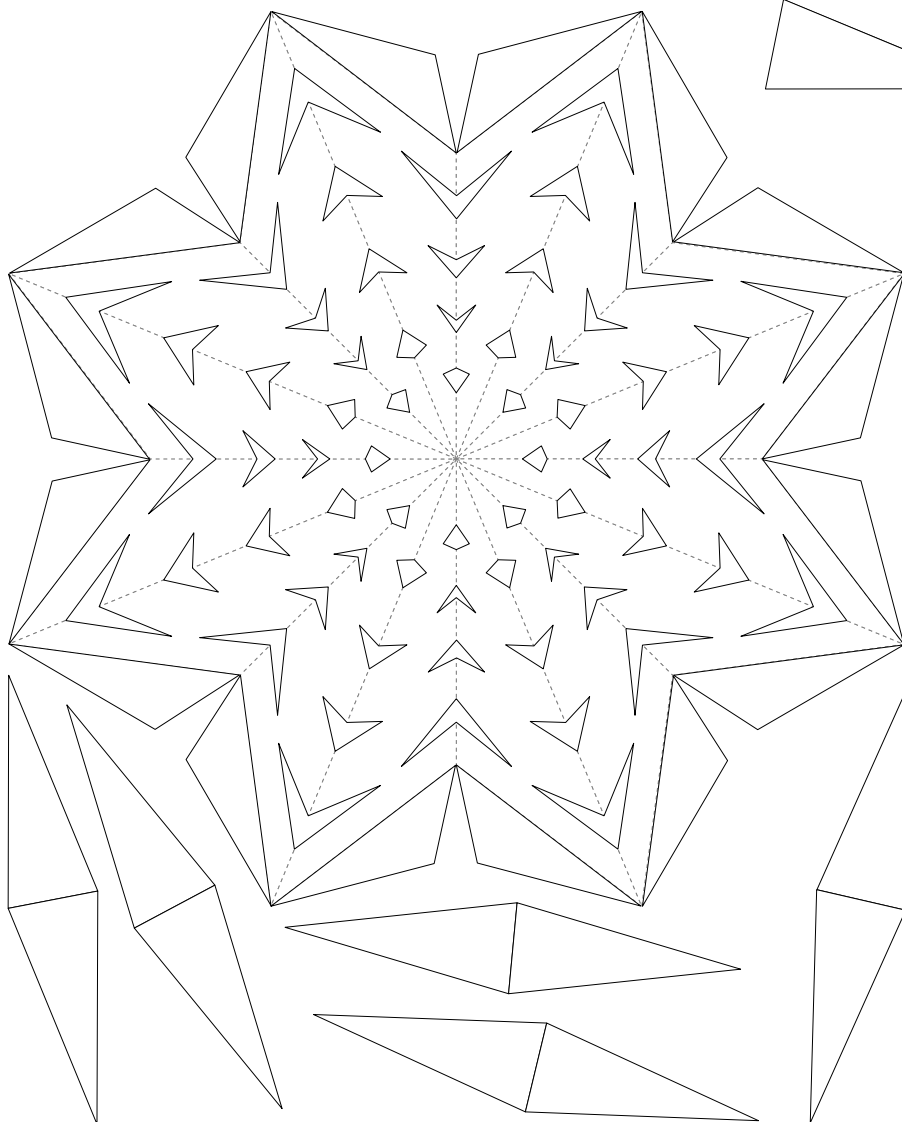

* PBB 2012 *

Projekt Bastelbogen

www.projekt-bastelbogen.de

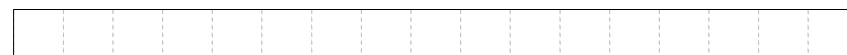

Bastelbogen Nr. 908o

kleiner 8-Spitz Stern, einseitig

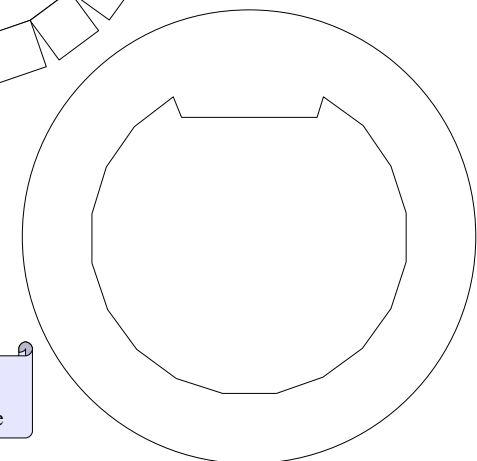
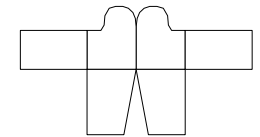
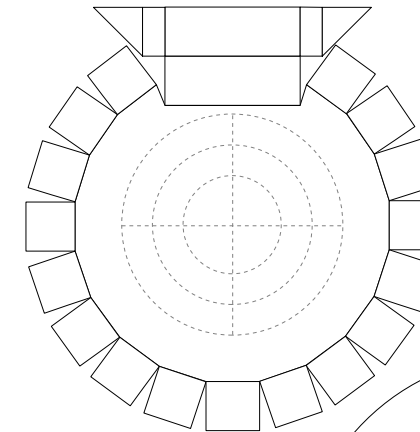
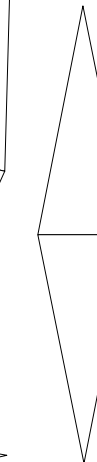
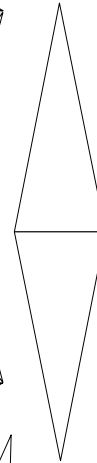
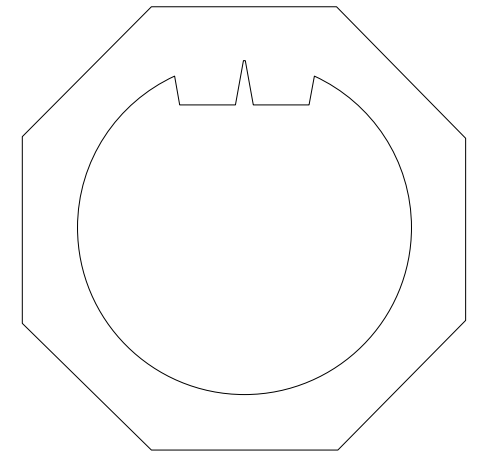
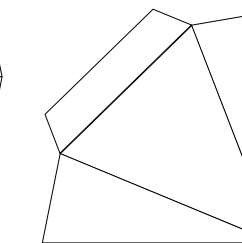
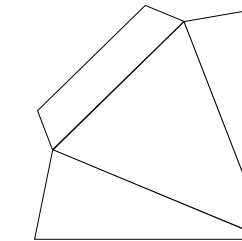
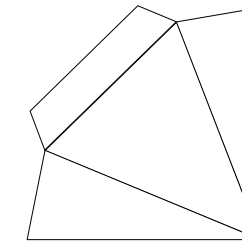
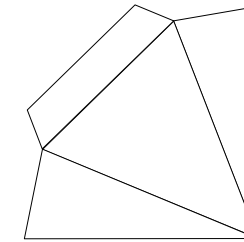
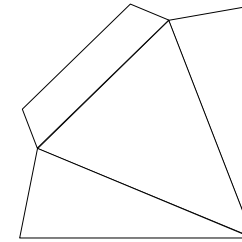
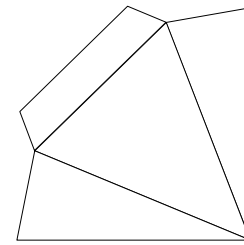
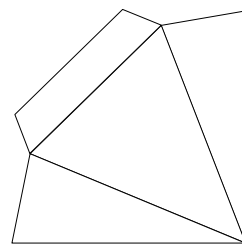
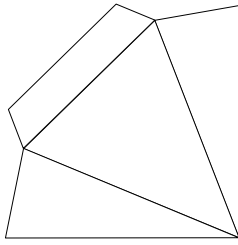
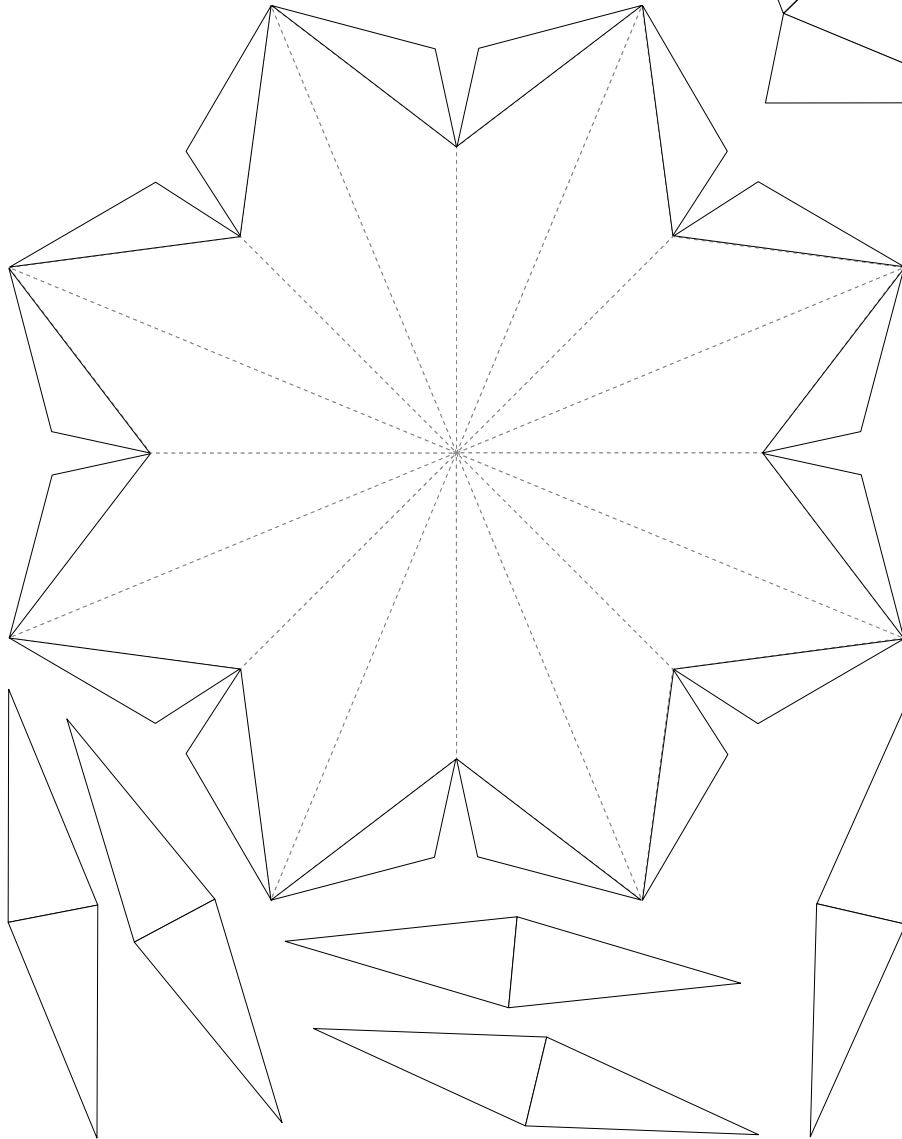

Projekt Bastelbogen

www.projekt-bastelbogen.de

