

Durchmesser : 21,6 cm
Höhe : 7,3 cm
Seiten : 6
Anzahl der Teile: 43

Schwierigkeit: S4, mittelschwer

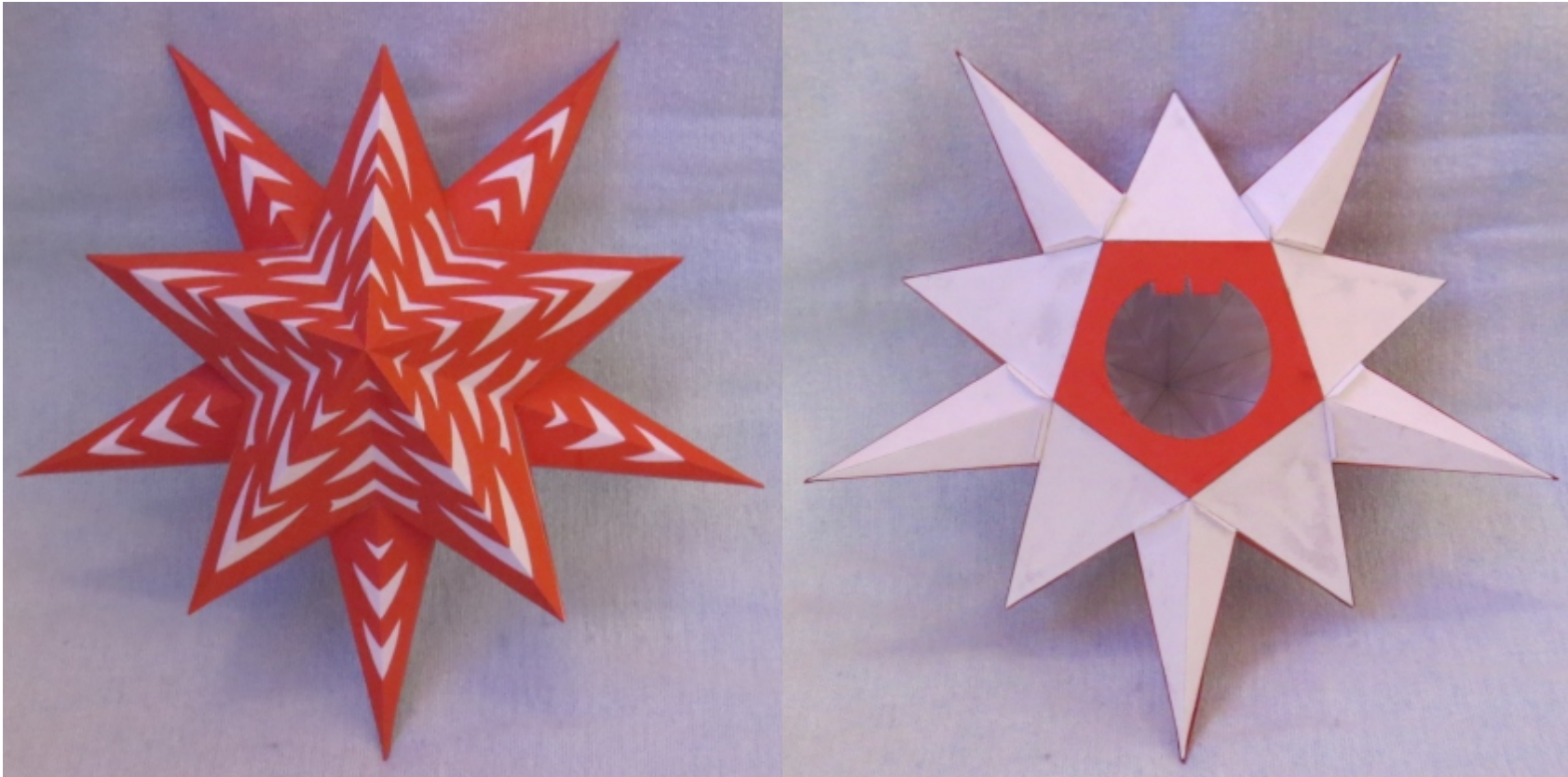

In der Rückwand (Teil 12) befindet sich die Öffnung passend für die kleine Standardhalterung mit Gehäuse Nr. 999y oder 999k.



Die Einzelteile sollten in der Reihenfolge der Nummerierung zusammengebaut werden.

Für die Herstellung des Sternes werden verschiedene Materialien benötigt:
Seite 2 bis 4: Kopierpapier; Seite 5 und 6: buntes Kopierpapier

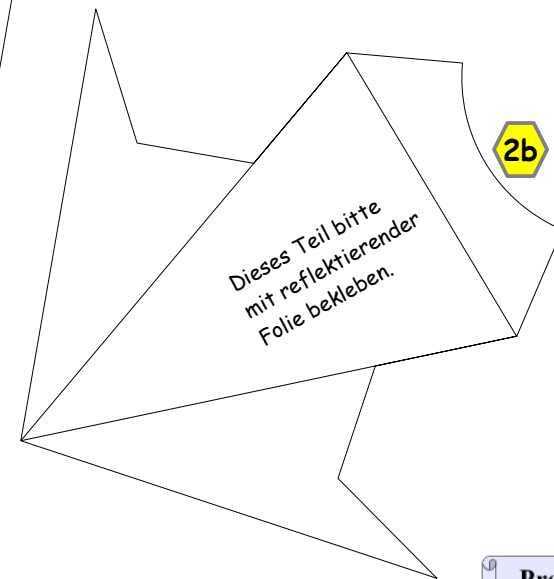
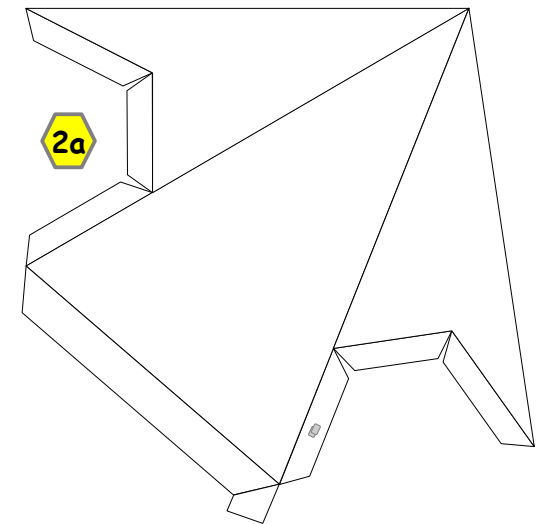
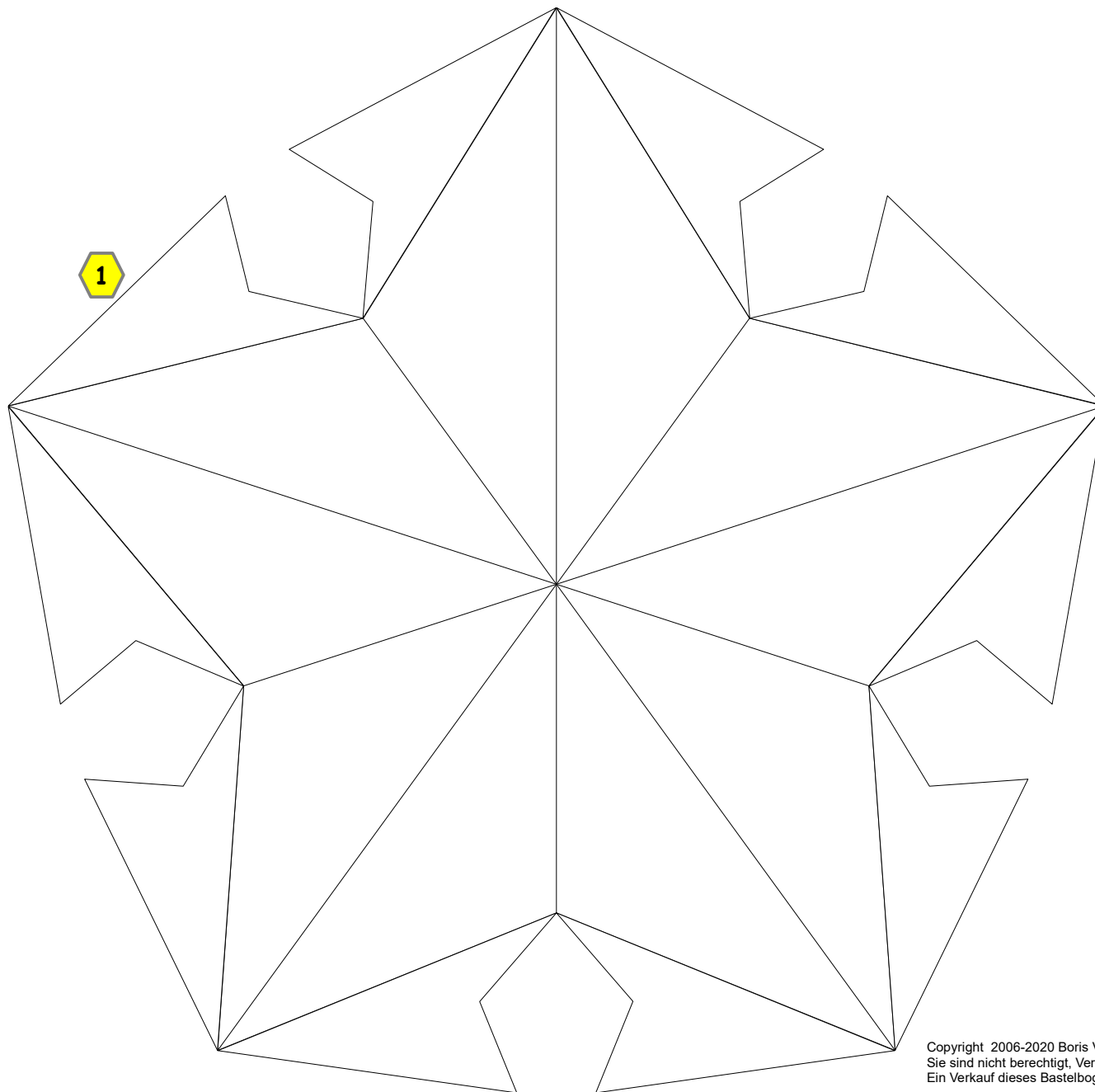

Projekt Bastelbogen
www.projekt-bastelbogen.de

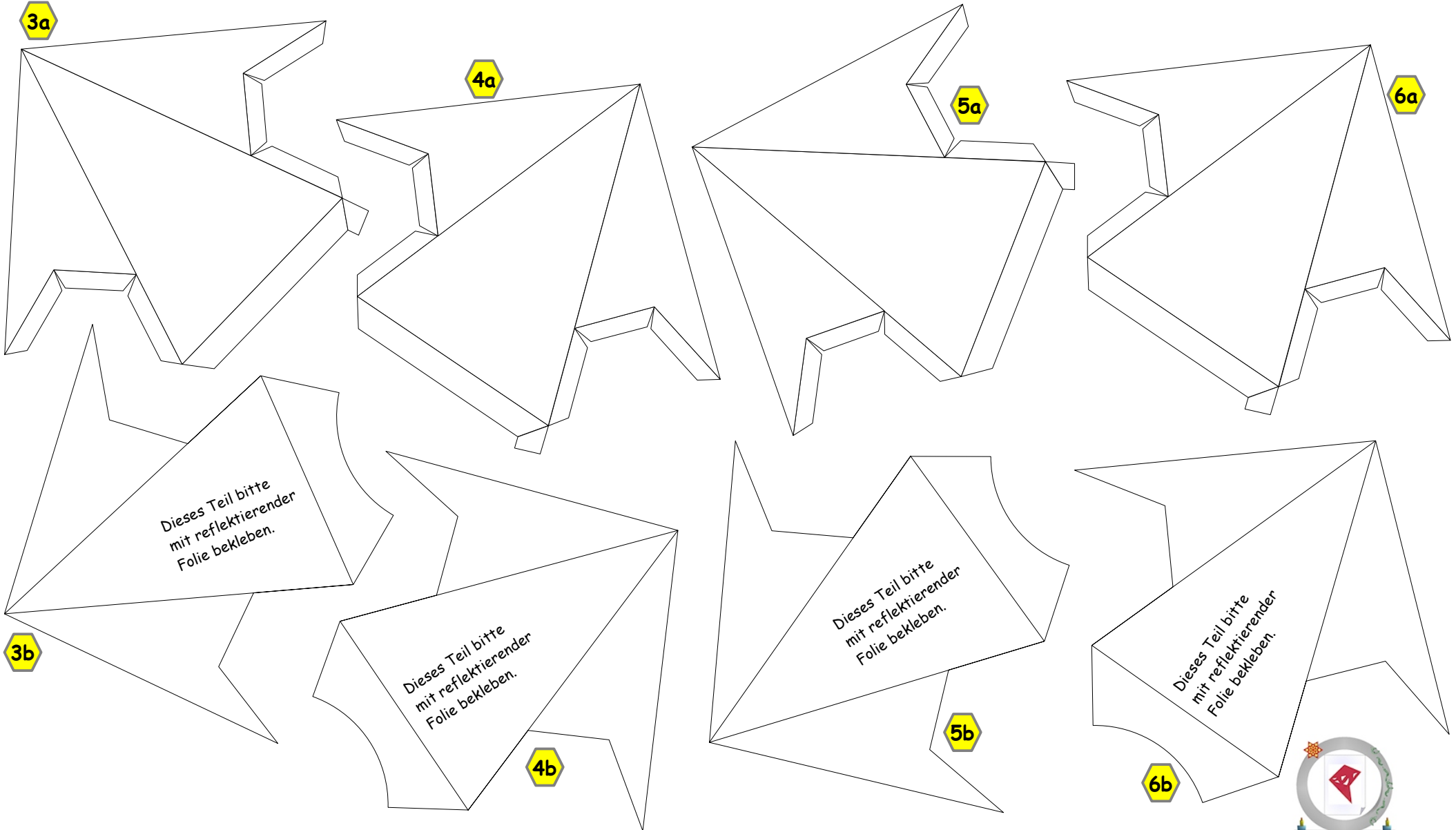

Bastelbogen Nr. 905p

5-Spitzstern mit Zwischenspitzen

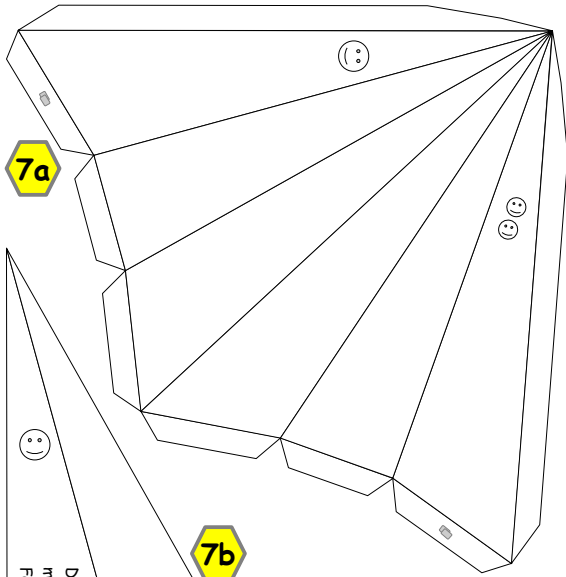

7a

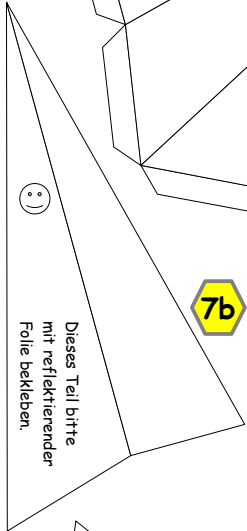

7b

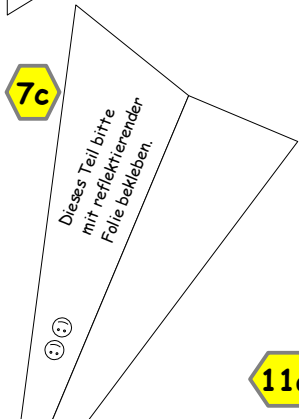

7c

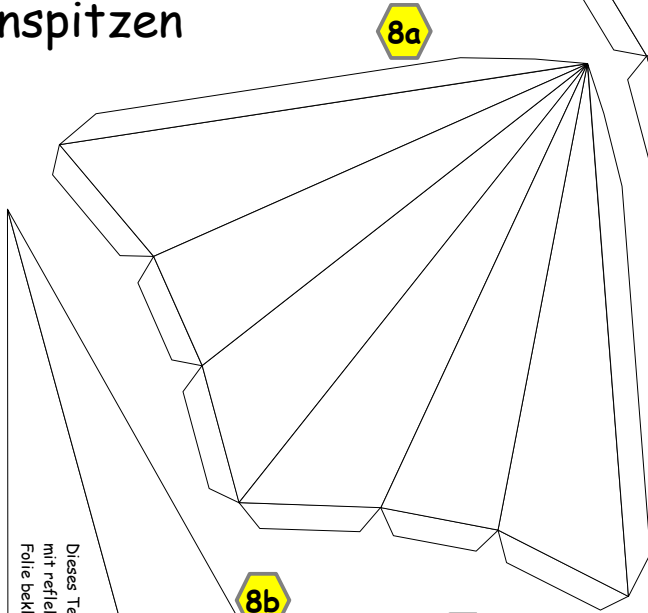

8a

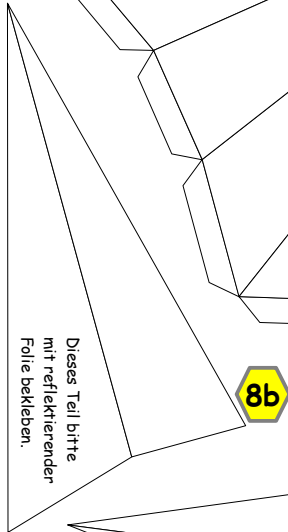

8b

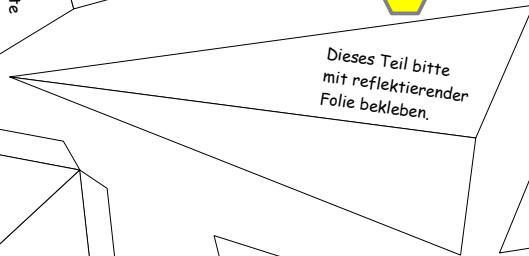

8c

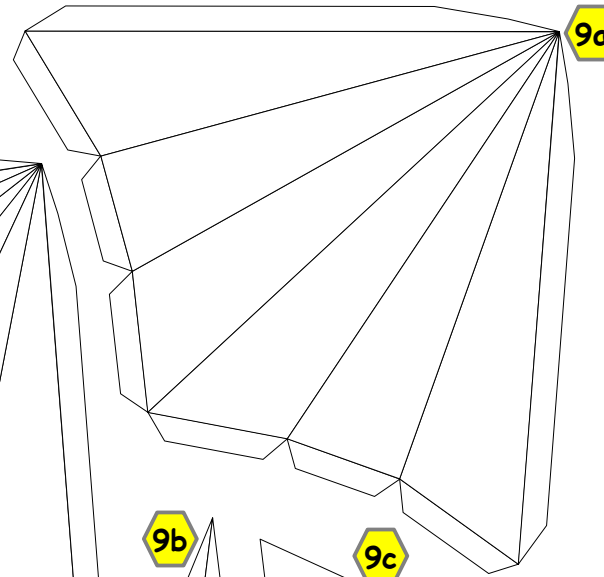

9a

9b

9c

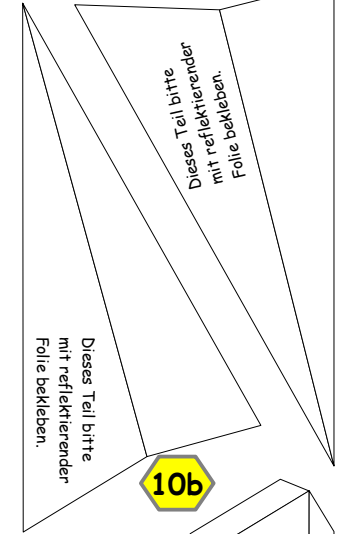

10b

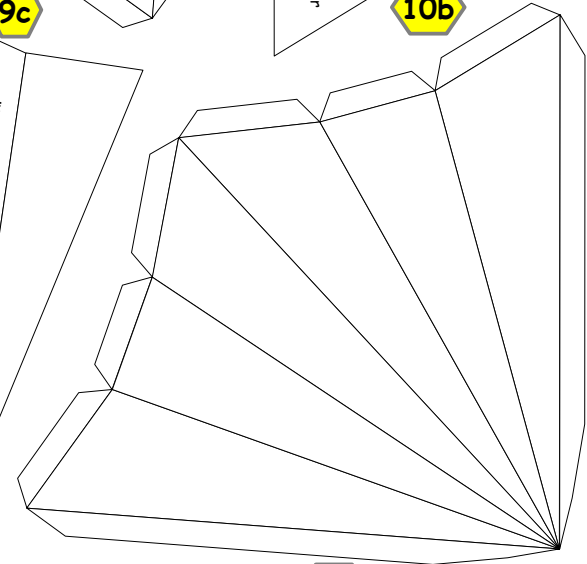

10a



11b

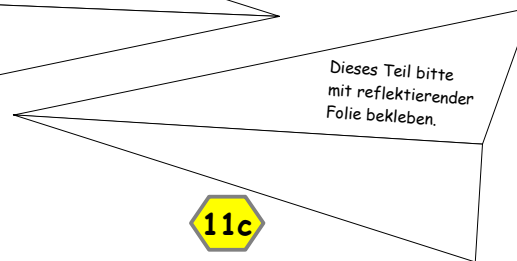

11c

Dieses Teil bitte mit reflektierender Folie bekleben.

Dieses Teil bitte mit reflektierender Folie bekleben.

Dieses Teil bitte mit reflektierender Folie bekleben.

Dieses Teil bitte mit reflektierender Folie bekleben.

Dieses Teil bitte mit reflektierender Folie bekleben.

Dieses Teil bitte mit reflektierender Folie bekleben.

Dieses Teil bitte mit reflektierender Folie bekleben.

Dieses Teil bitte mit reflektierender Folie bekleben.



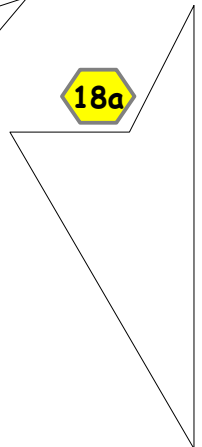
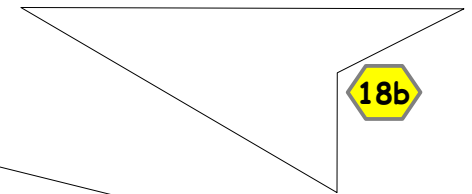
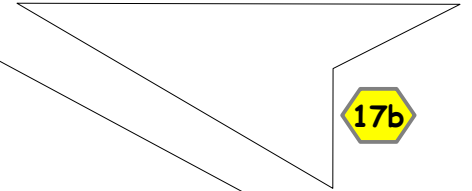
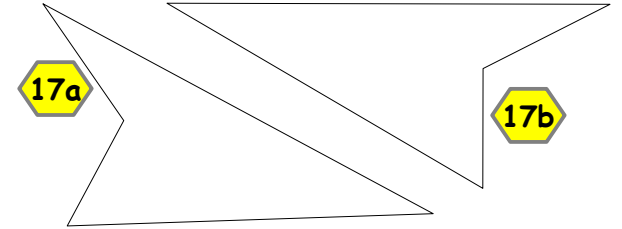
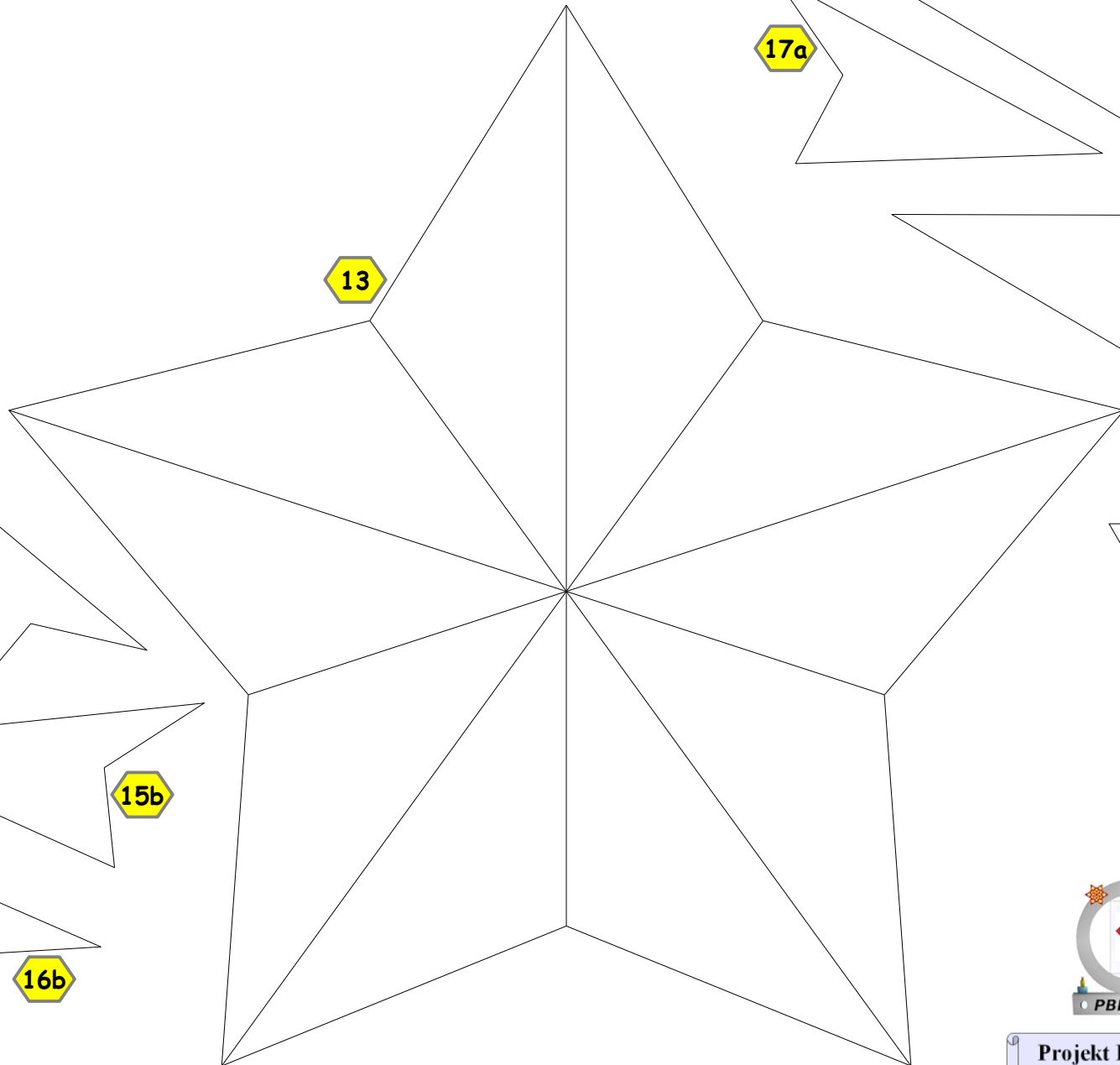
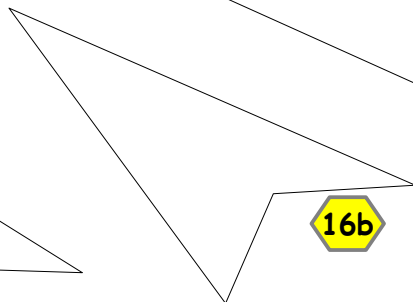
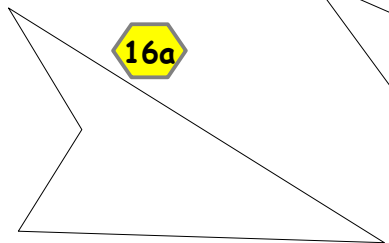
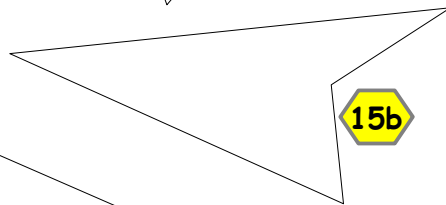
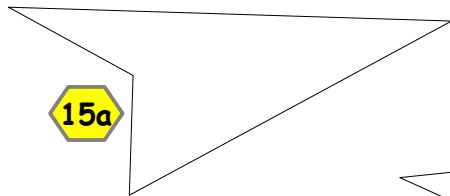
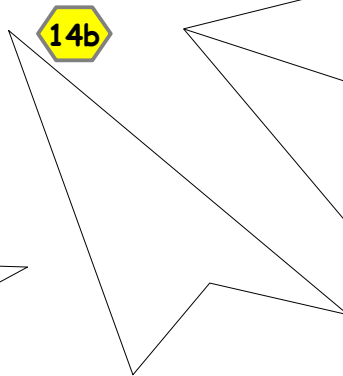
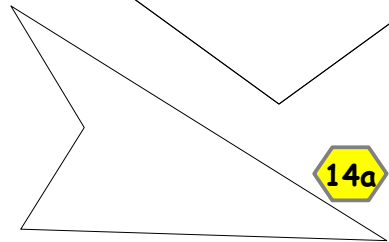
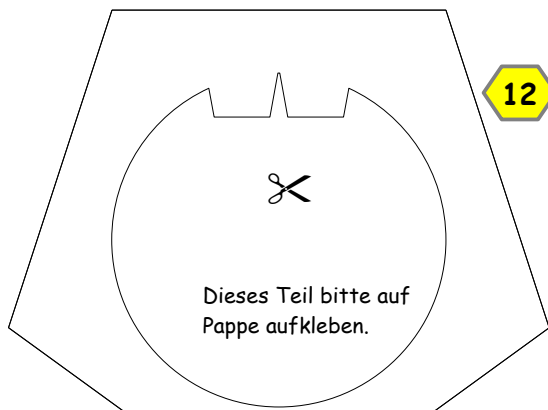

19

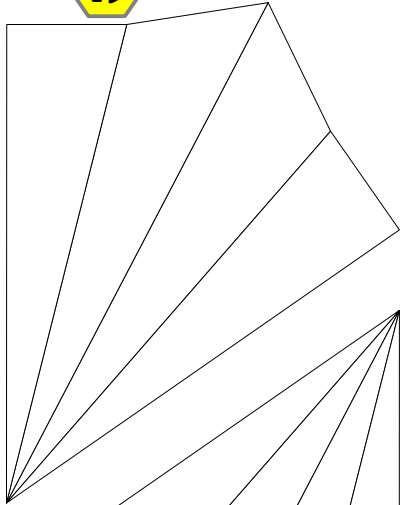

20

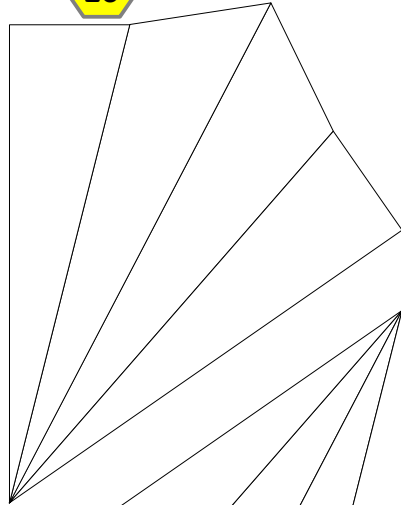

21

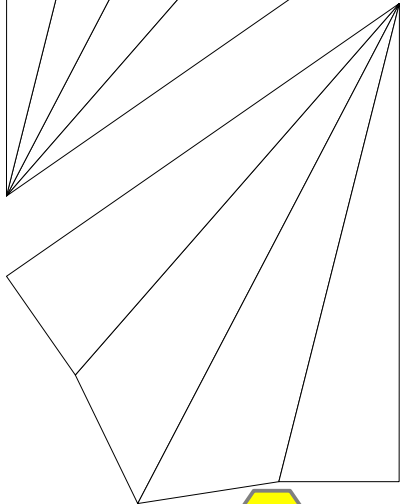

22

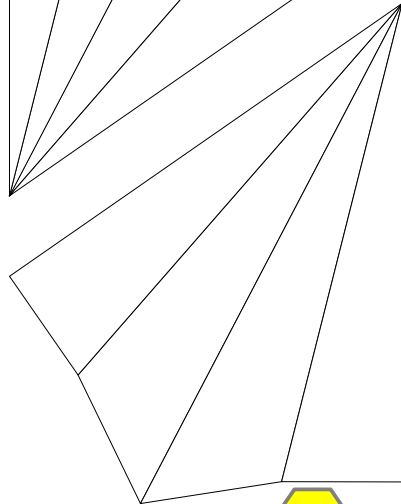

23



Bild: verwendete Schablonen für Haupt- und Zwischenspitzen mit Scherenschnitt



Schablone für Oberfläche (Scherenschnitt)

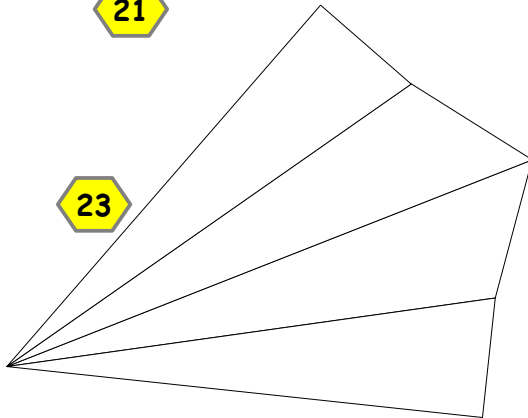
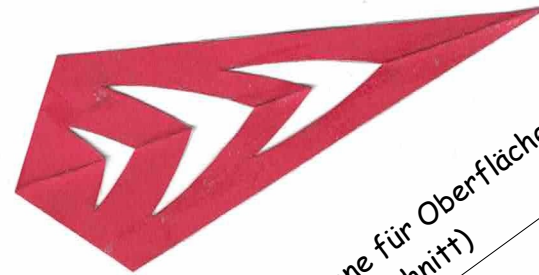
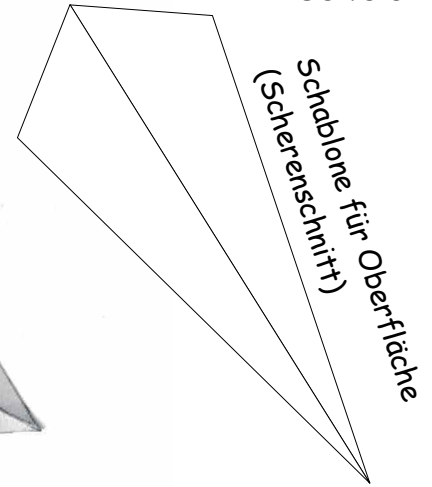

Schablone für Oberfläche (Scherenschnitt)

Mitte

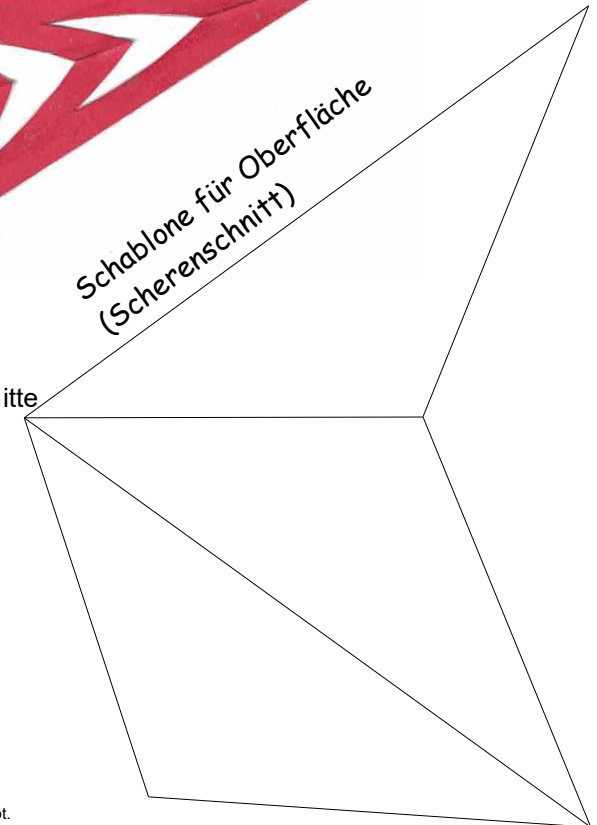

Spitze



Projekt Bastelbogen
www.projekt-bastelbogen.de