

# Bastelbogen Nr. 503b

## Triebwagen TBW 15 (rot)

Schwierigkeit: S6 sehr schwer

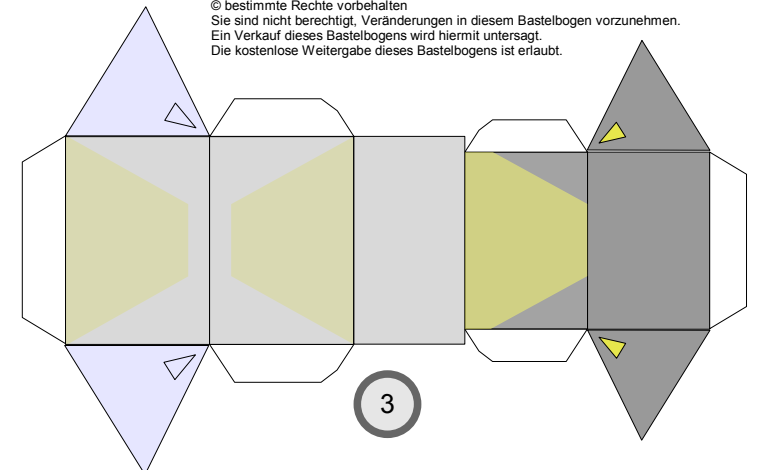
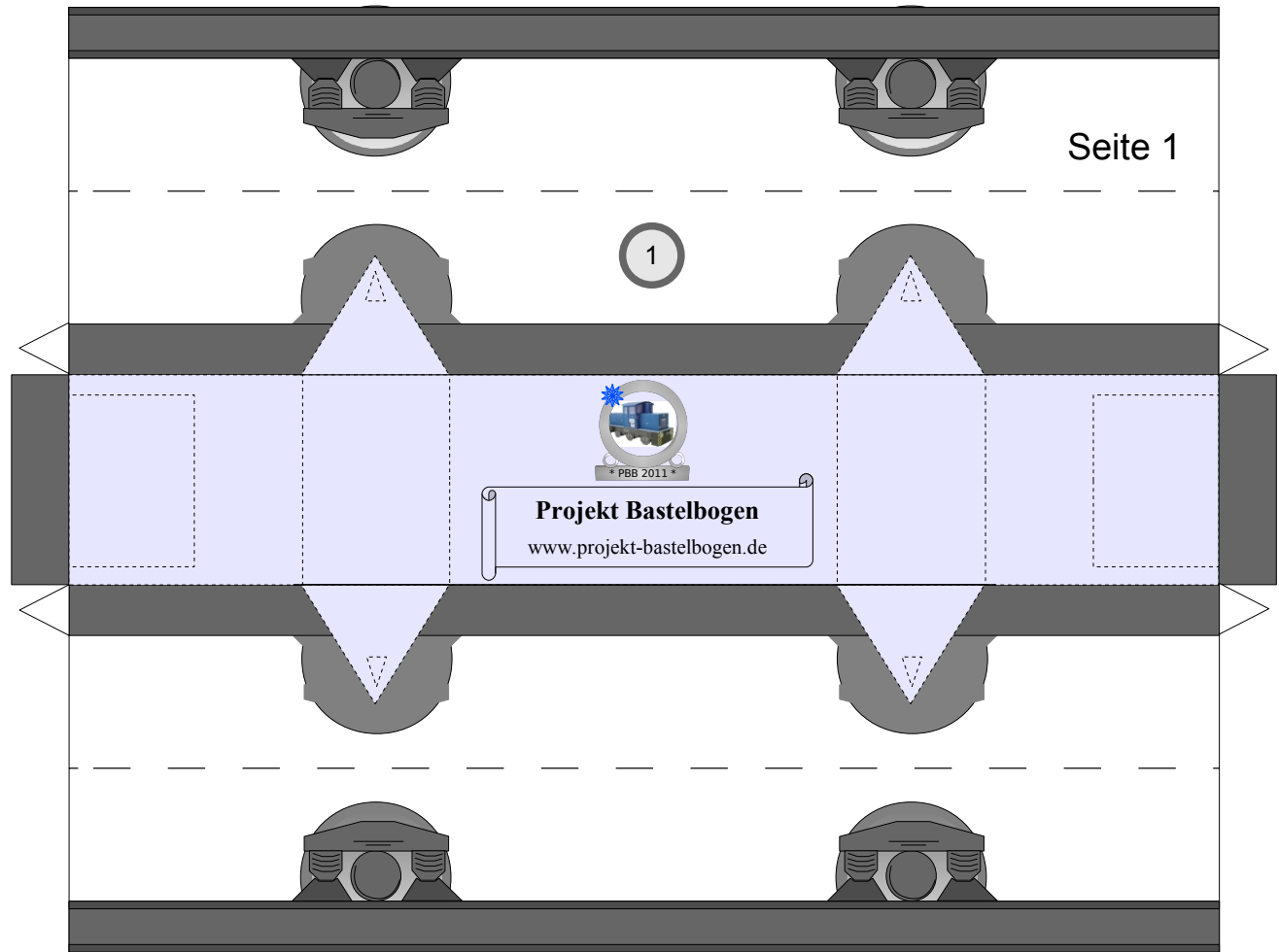
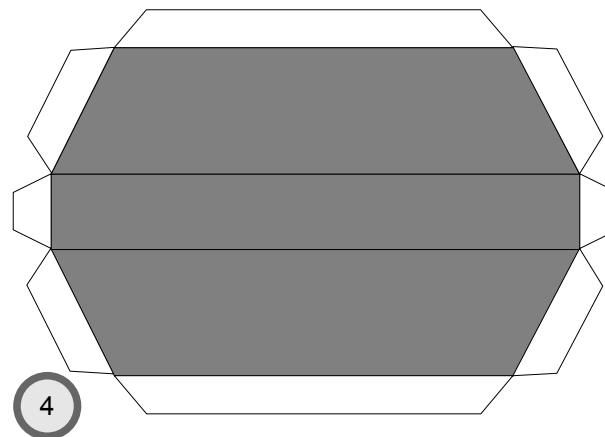
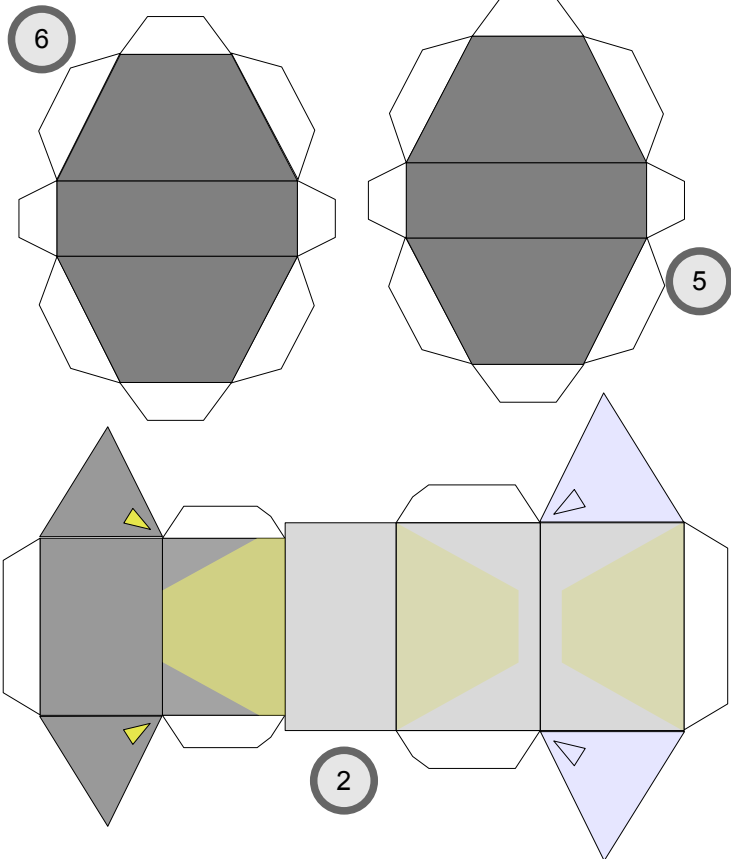

Copyright 2006-2011 Boris Voigt, Berlin-Hohenschönhausen  
© bestimmte Rechte vorbehalten  
Sie sind nicht berechtigt, Veränderungen in diesem Bastelbogen vorzunehmen.  
Ein Verkauf dieses Bastelbogens wird hiermit untersagt.  
Die kostenlose Weitergabe dieses Bastelbogens ist erlaubt.

# Bastelbogen Nr. 503b

## Triebwagen

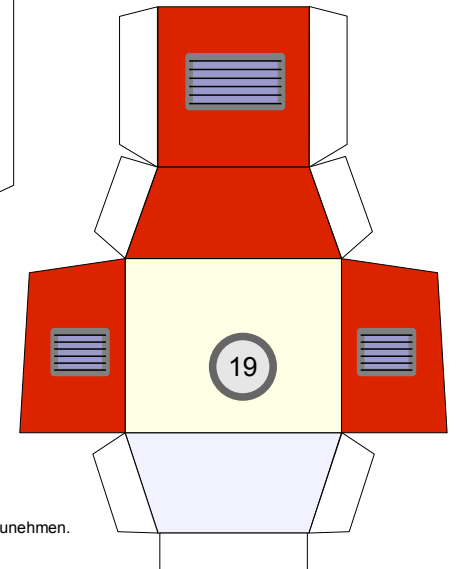
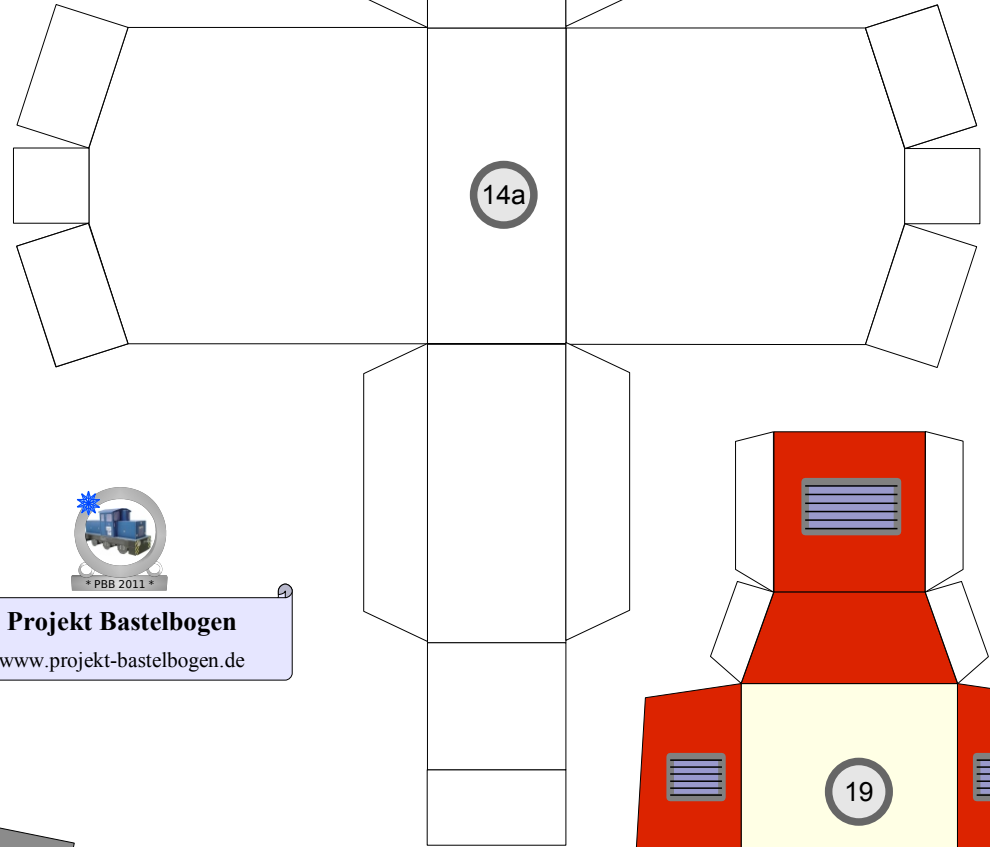
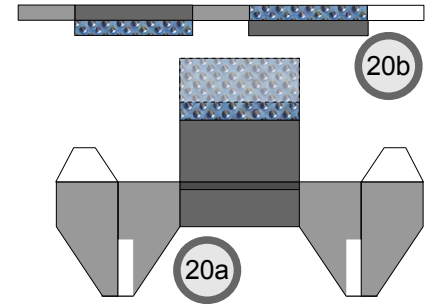
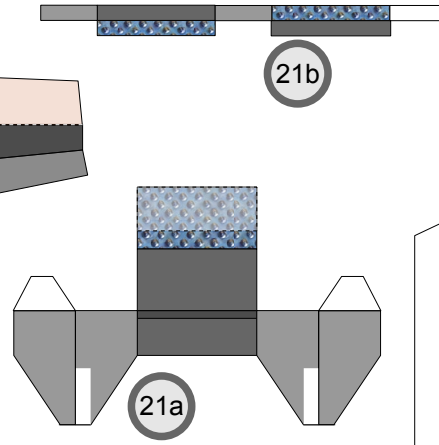
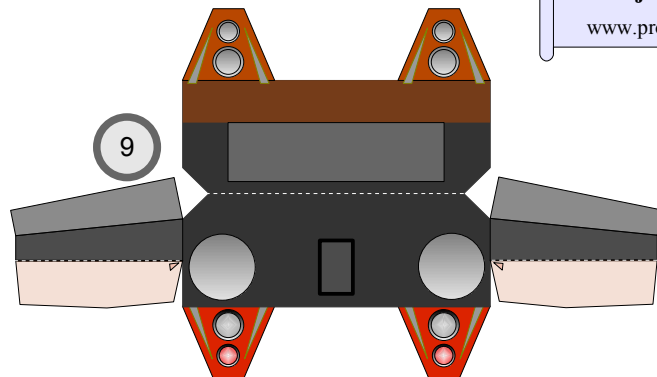
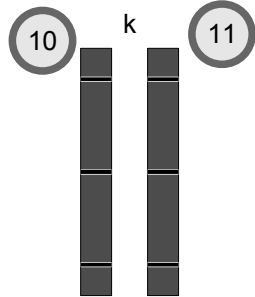
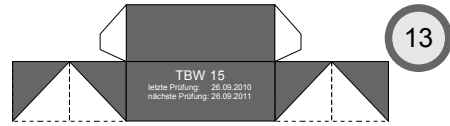
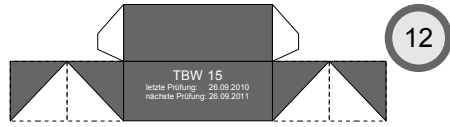
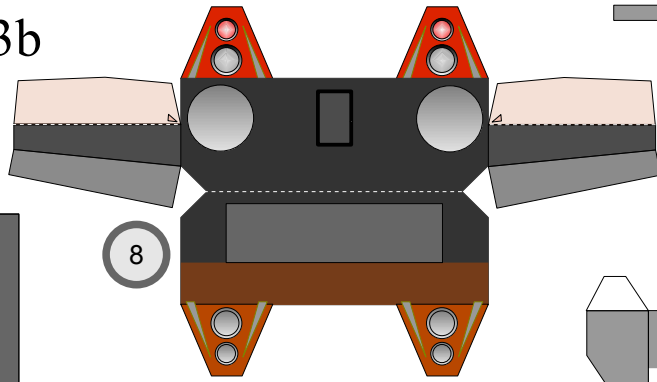
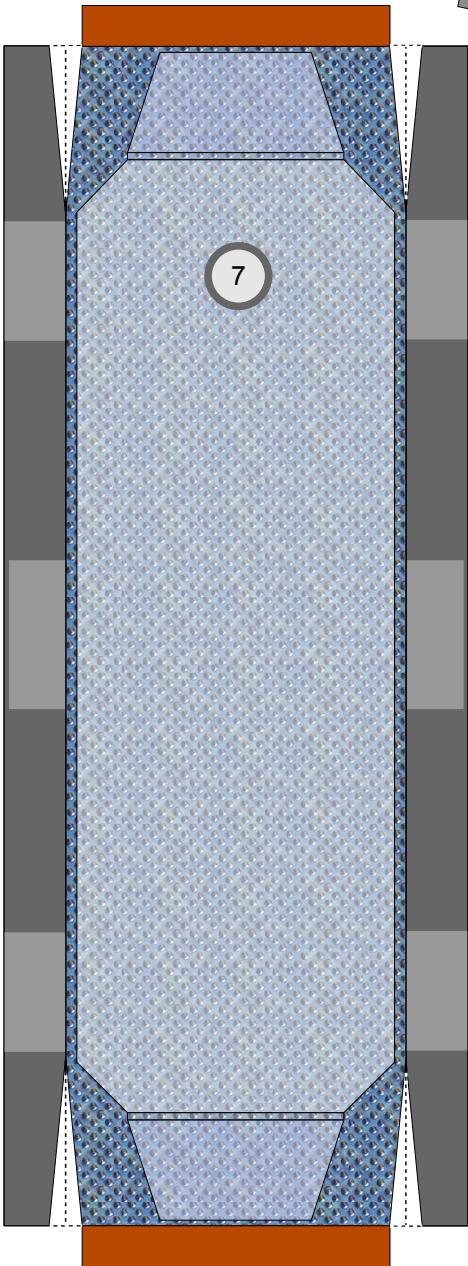

Copyright 2006-2011 Boris Voigt, Berlin-Hohenschönhausen  
© bestimmte Rechte vorbehalten  
Sie sind nicht berechtigt, Veränderungen in diesem Bastelbogen vorzunehmen.  
Ein Verkauf dieses Bastelbogens wird hiermit untersagt.  
Die kostenlose Weitergabe dieses Bastelbogens ist erlaubt.

# Bastelbogen Nr. 503b

## Triebwagen

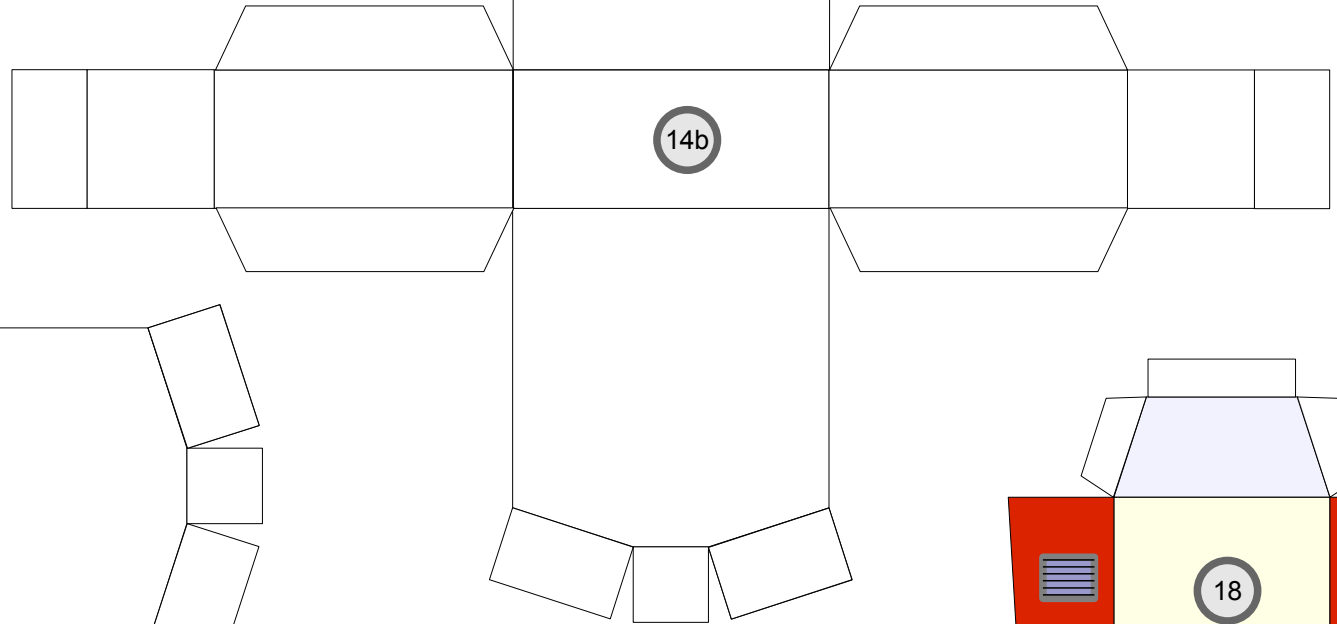
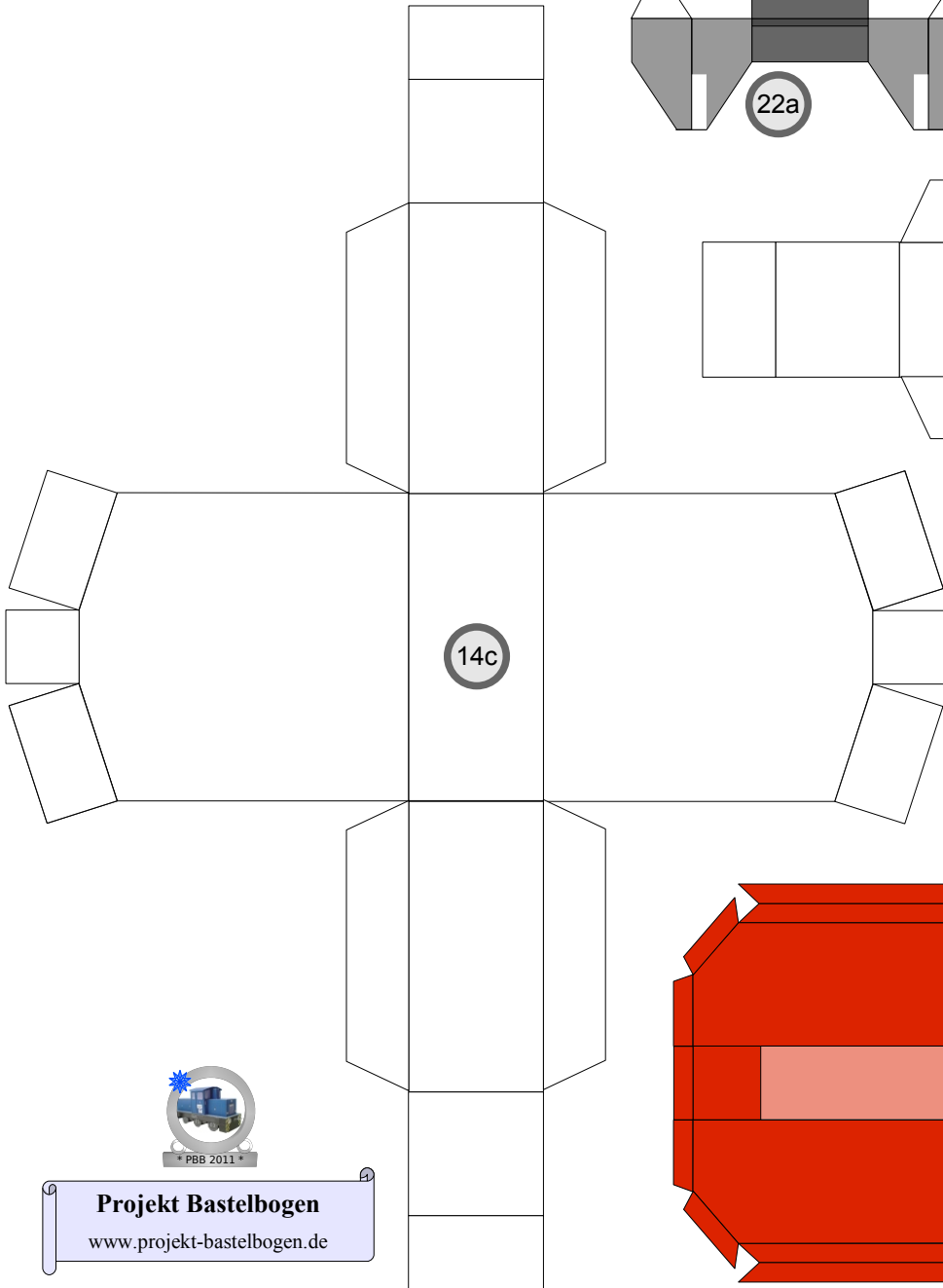
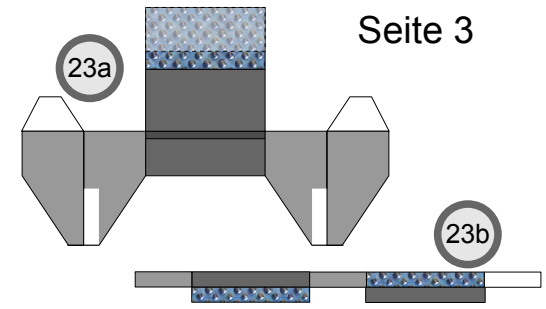
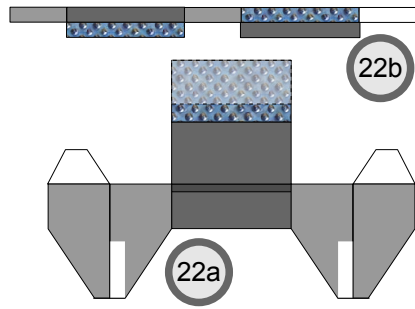

Copyright 2006-2011 Boris Voigt, Berlin-Hohenschönhausen  
© bestimmte Rechte vorbehalten  
Sie sind nicht berechtigt, Veränderungen in diesem Bastelbogen vorzunehmen.  
Ein Verkauf dieses Bastelbogens wird hiermit untersagt.  
Die kostenlose Weitergabe dieses Bastelbogens ist erlaubt.

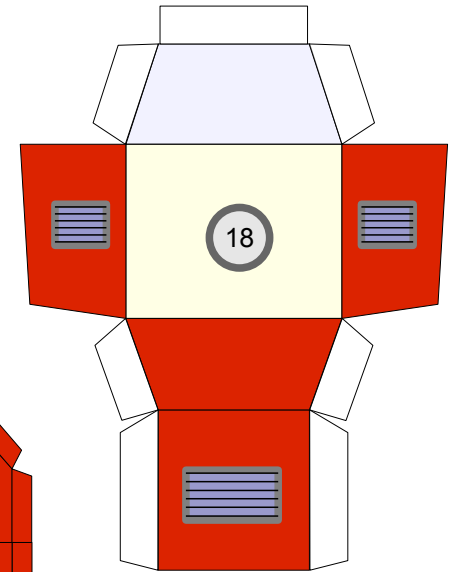

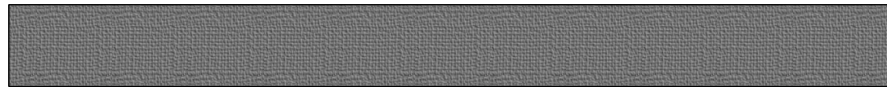
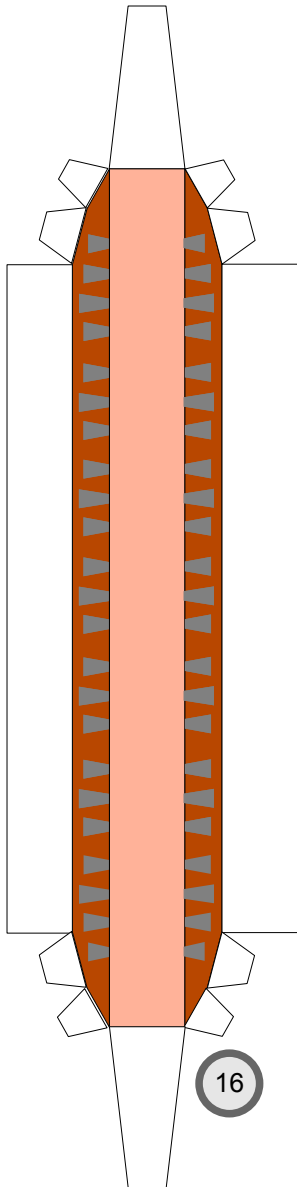

17

